

IGBT Discrete

V_{CE}	1200	V
I_C	75	A
$V_{CE(SAT)} I_C=75A$	1.65	V

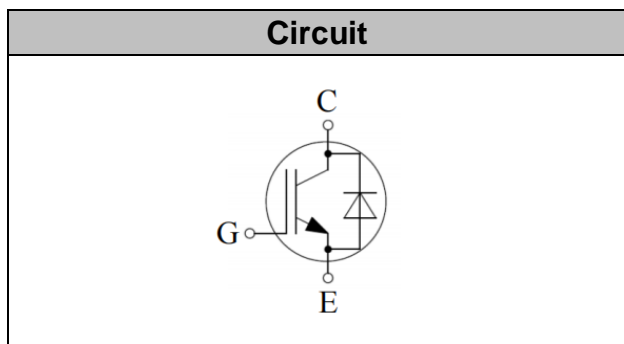

Applications

- PV power
- Uninterruptible power supplies
- Three-level Solar String Inverter

Features

- High speed smooth switching device for hard & soft switching
- Maximum junction temperature 175°C
- Positive temperature coefficient
- High ruggedness, temperature stable

Maximum Ratings

Parameter	Symbol	Value	Unit
Collector-Emitter Breakdown Voltage	V_{CE}	1200	V
DC Collector Current, limited by T_{jmax} $T_C=25^{\circ}C$ $T_C=100^{\circ}C$	I_C	150 75	A
Diode Forward Current, limited by T_{jmax} $T_C=25^{\circ}C$ $T_C=100^{\circ}C$	I_F	150 75	A
Continuous Gate-Emitter Voltage	V_{GE}	± 20	V
Transient Gate-Emitter Voltage ($t_p \leq 10\mu s, D < 0.010$)	V_{GE}	± 30	V
Turn off Safe Operating Area $V_{CE} \leq 1200V$, $T_j \leq 150^{\circ}C$		300	A
Pulsed Collector Current, $V_{GE}=15V$, t_p limited by T_{jmax}	I_{CM}	300	A
Diode Pulsed Current, t_p limited by T_{jmax}	I_{Fpuls}	300	A
Power Dissipation, $T_j=175^{\circ}C$, $T_C=25^{\circ}C$	P_{tot}	535	W



Operating Junction Temperature	T_j	-40...+175	°C
Storage Temperature	T_s	-55...+150	°C
Soldering Temperature, wave soldering 1.6mm (0.063in.) from case for 10s		260	°C

Electrical Characteristics of the IGBT ($T_j = 25^\circ\text{C}$ unless otherwise specified):

Parameter	Symbol	Conditions	Min.	Typ.	Max.	Unit
Static						
Collector-Emitter Breakdown Voltage	BV_{CES}	$V_{GE}=0V, I_C=250\mu A$	1200		-	V
Gate Threshold Voltage	$V_{GE(th)}$	$V_{GE}=V_{CE}, I_C=1.4mA$	4.8	5.5	6.2	V
Collector-Emitter Saturation Voltage	$V_{CE(sat)}$	$V_{GE}=15V, I_C=75A$ $T_j=25^\circ\text{C}$, $T_j=125^\circ\text{C}$ $T_j=150^\circ\text{C}$	1.50	1.65 2.05 2.15	1.90	V
Zero Gate Voltage Collector Current	I_{CES}	$V_{CE}=1200V, V_{GE}=0V$ $T_j=25^\circ\text{C}$, $T_j=150^\circ\text{C}$			0.25 5	mA
Gate-Emitter Leakage Current	I_{GES}	$V_{CE}=0V, V_{GE}=\pm 20V$			100	nA

Parameter	Symbol	Conditions	Min.	Typ.	Max.	Unit
Dynamic						
Input Capacitance	C_{ies}	$V_{CE}=25V, V_{GE}=0V,$ $f=1MHz$	-	5.51	-	nF
Reverse Transfer Capacitance	C_{res}		-	0.05	-	
Gate Charge	Q_G	$V_{CC}=960V, I_C=75A,$ $V_{GE}=15V$	-	0.65	-	uC

**Electrical Characteristics of the Diode** ($T_j = 25^\circ\text{C}$ unless otherwise specified):

Parameter	Symbol	Conditions	Min.	Typ.	Max.	Unit
Static						
Diode Forward Voltage	V_F	$I_F = 75\text{A}$ $T_j = 25^\circ\text{C}$, $T_j = 125^\circ\text{C}$ $T_j = 150^\circ\text{C}$		2.40 2.10 2.00	3.00	V

Switching Characteristic, Inductive Load

Parameter	Symbol	Conditions	Min.	Typ.	Max.	Unit
Dynamic , at $T_j = 25^\circ\text{C}$						
Turn-on Delay Time	$t_{d(\text{on})}$	$V_{CC} = 600\text{V}$, $I_C = 75\text{A}$, $V_{GE} = -5\text{V} \sim 15\text{V}$, $R_g = 10\Omega$	-	52	-	ns
Rise Time	t_r		-	58	-	ns
Turn-on Energy	E_{on}		-	5.25	-	mJ
Turn-off Delay Time	$t_{d(\text{off})}$		-	80	-	ns
Fall Time	t_f		-	85	-	ns
Turn-off Energy	E_{off}		-	1.87	-	mJ
Dynamic , at $T_j = 125^\circ\text{C}$						
Turn-on Delay Time	$t_{d(\text{on})}$	$V_{CC} = 600\text{V}$, $I_C = 75\text{A}$, $V_{GE} = -5\text{V} \sim 15\text{V}$, $R_g = 10\Omega$	-	53	-	ns
Rise Time	t_r		-	60	-	ns
Turn-on Energy	E_{on}		-	5.42	-	mJ
Turn-off Delay Time	$t_{d(\text{off})}$		-	90	-	ns
Fall Time	t_f		-	100	-	ns
Turn-off Energy	E_{off}		-	2.36	-	mJ
Dynamic , at $T_j = 150^\circ\text{C}$						
Turn-on Delay Time	$t_{d(\text{on})}$	$V_{CC} = 600\text{V}$, $I_C = 75\text{A}$, $V_{GE} = -5\text{V} \sim 15\text{V}$, $R_g = 10\Omega$	-	54	-	ns
Rise Time	t_r		-	62	-	ns
Turn-on Energy	E_{on}		-	5.51	-	mJ
Turn-off Delay Time	$t_{d(\text{off})}$		-	95	-	ns
Fall Time	t_f		-	108	-	ns
Turn-off Energy	E_{off}		-	2.49	-	mJ



Electrical Characteristics of the DIODE

Parameter	Symbol	Conditions	Min.	Typ.	Max.	Unit
Dynamic , at T_j= 25°C						
Reverse Recovery Current	I _{rr}	I _F =75A, V _R =600V, di/dt= -500A/μs	-	11	-	A
Diode reverse recovery time	trr		-	189	-	ns
Reverse Recovery Charge	Q _{rr}		-	3.01	-	uC
Reverse Recovery Energy	E _{rec}		-	1.35	-	mJ
Dynamic , at T_j= 125°C						
Reverse Recovery Current	I _{rr}	I _F =75A, V _R =600V, di/dt= -500A/μs	-	15	-	A
Diode reverse recovery time	trr		-	235	-	ns
Reverse Recovery Charge	Q _{rr}		-	6.74	-	uC
Reverse Recovery Energy	E _{rec}		-	2.92	-	mJ
Dynamic , at T_j= 150°C						
Reverse Recovery Current	I _{rr}	I _F =75A, V _R =600V, di/dt= -500A/μs	-	16	-	A
Diode reverse recovery time	trr		-	278	-	ns
Reverse Recovery Charge	Q _{rr}		-	8.47	-	uC
Reverse Recovery Energy	E _{rec}		-	3.28	-	mJ

Thermal Resistance

Parameter	Symbol	Max. Value	Unit
IGBT Thermal Resistance, Junction - Case	R _{th(j-c)}	0.28	K/W
Diode Thermal Resistance, Junction - Case	R _{th(j-c)}	0.35	K/W
Thermal Resistance, Junction - Ambient	R _{th(j-a)}	40	K/W

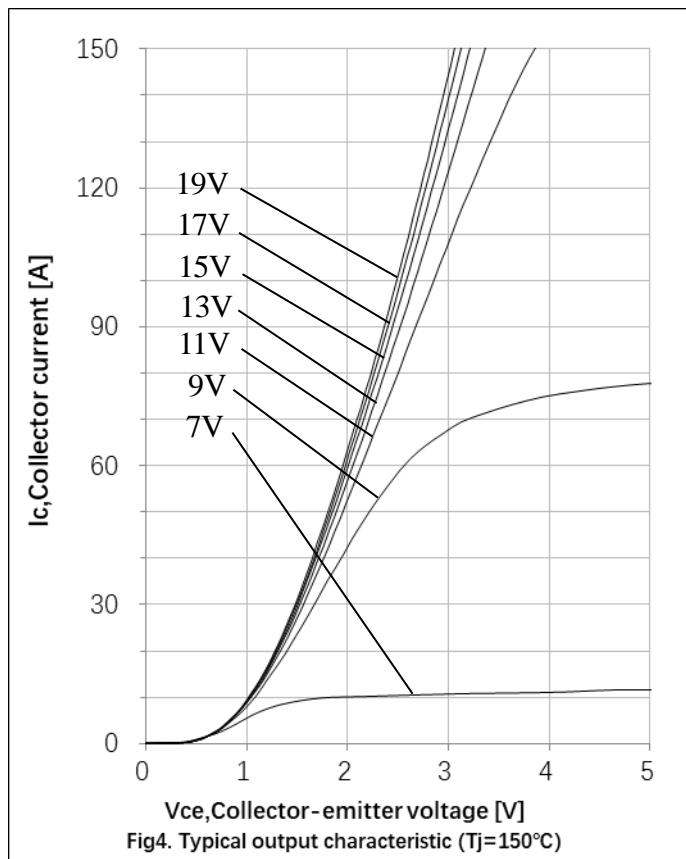
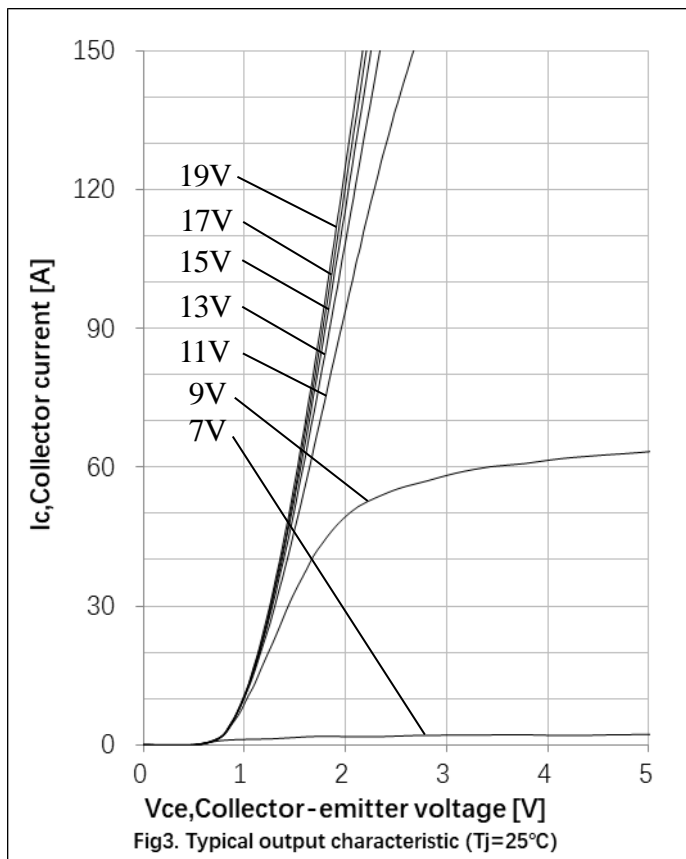
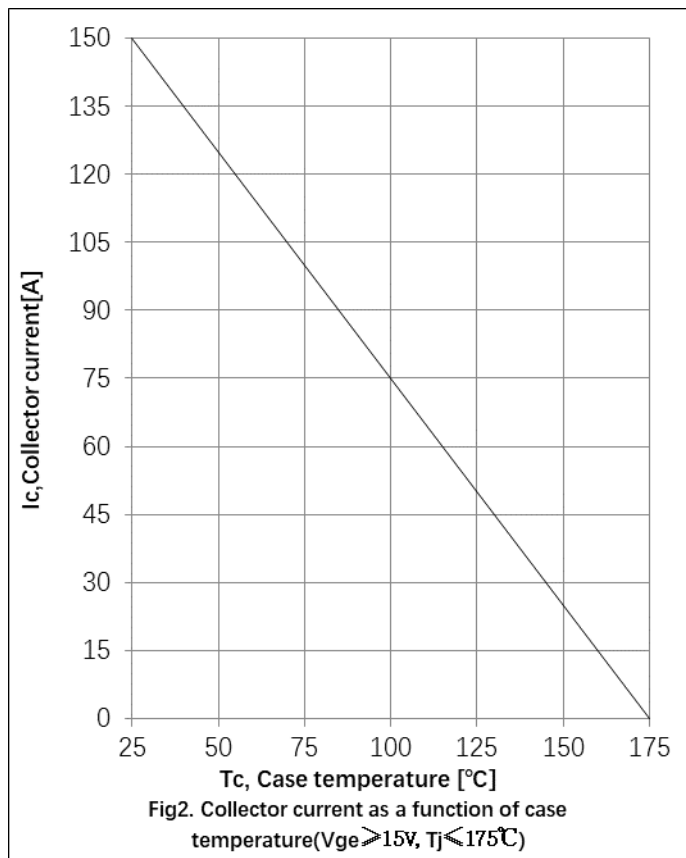
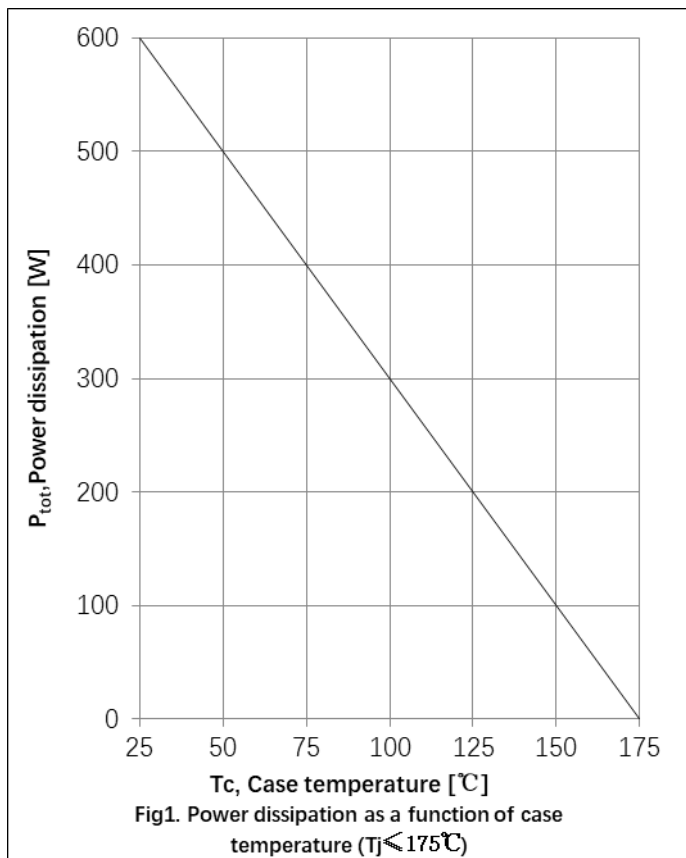

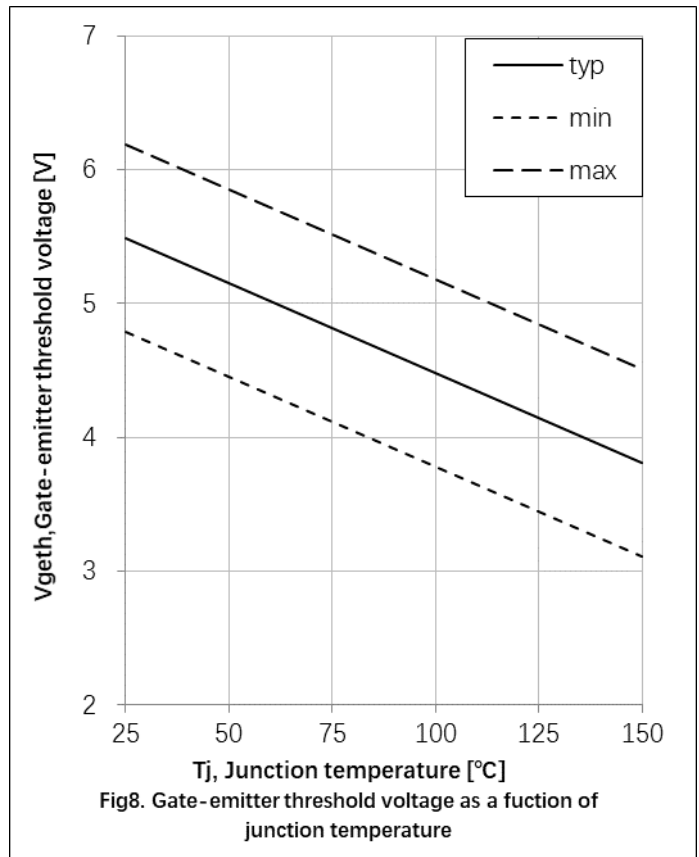
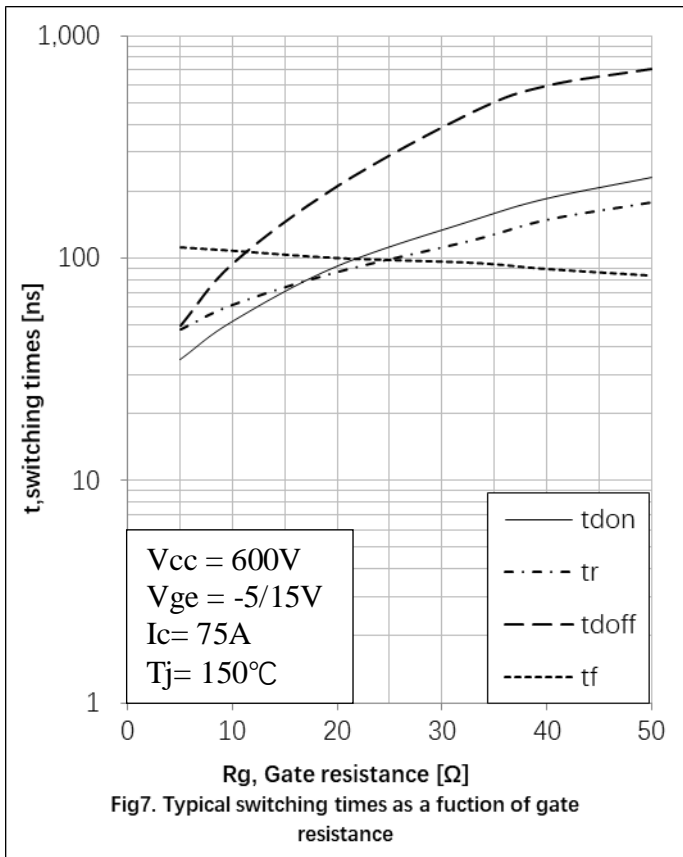
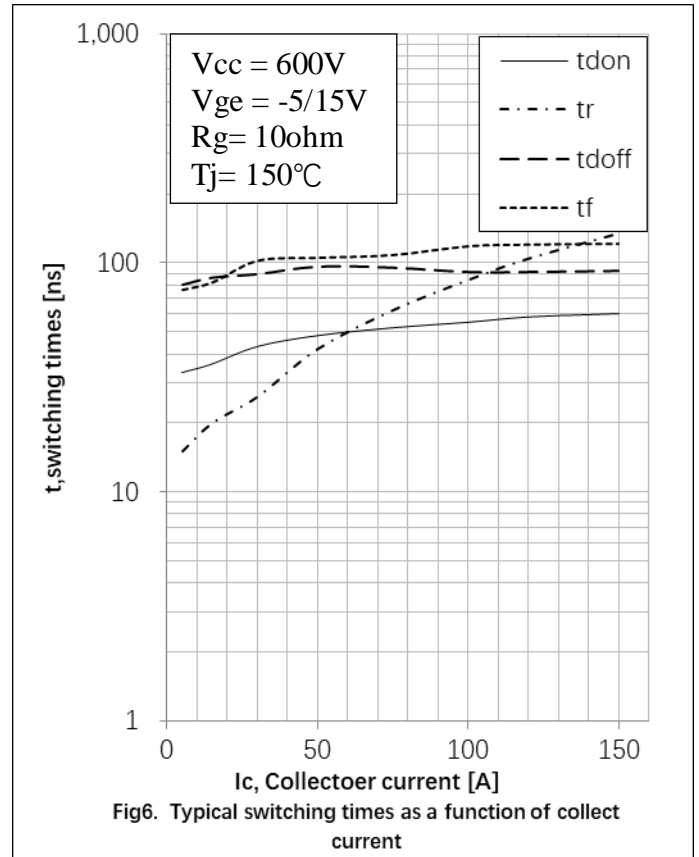
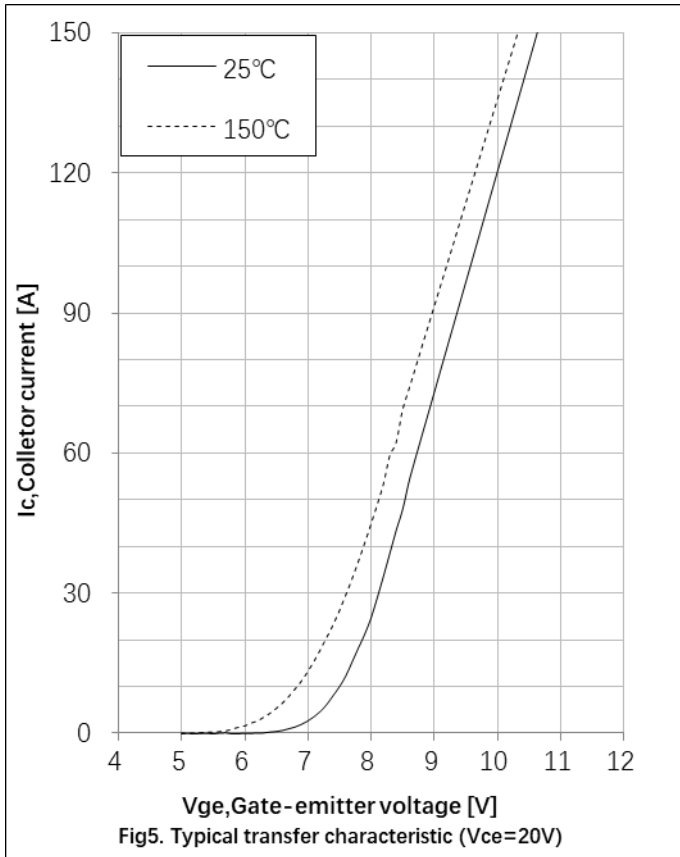

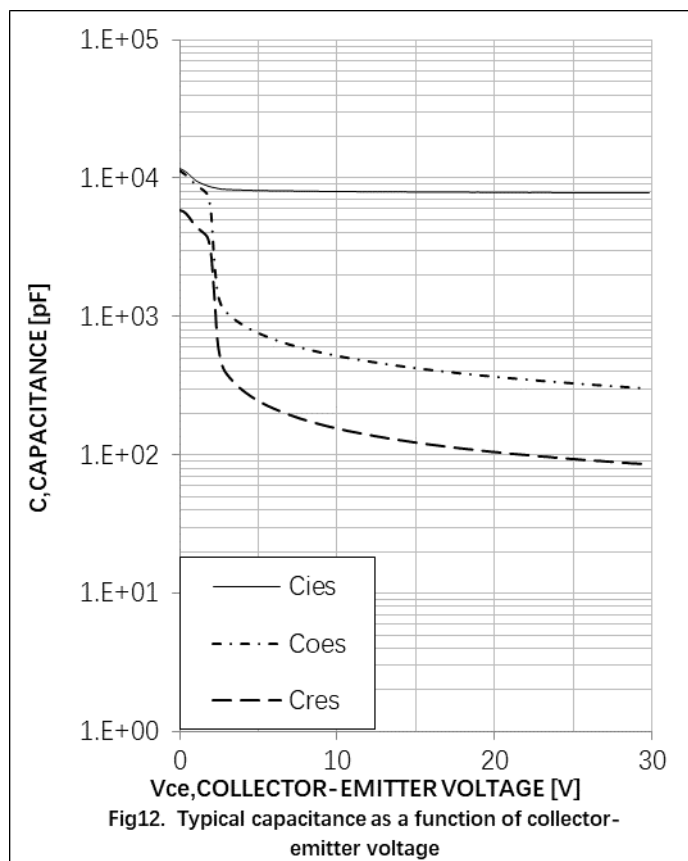
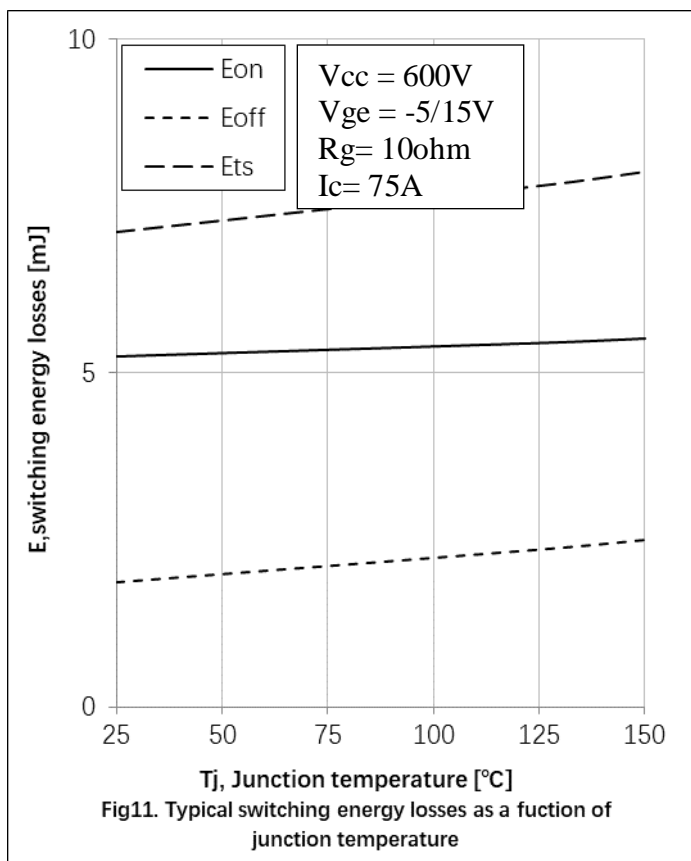
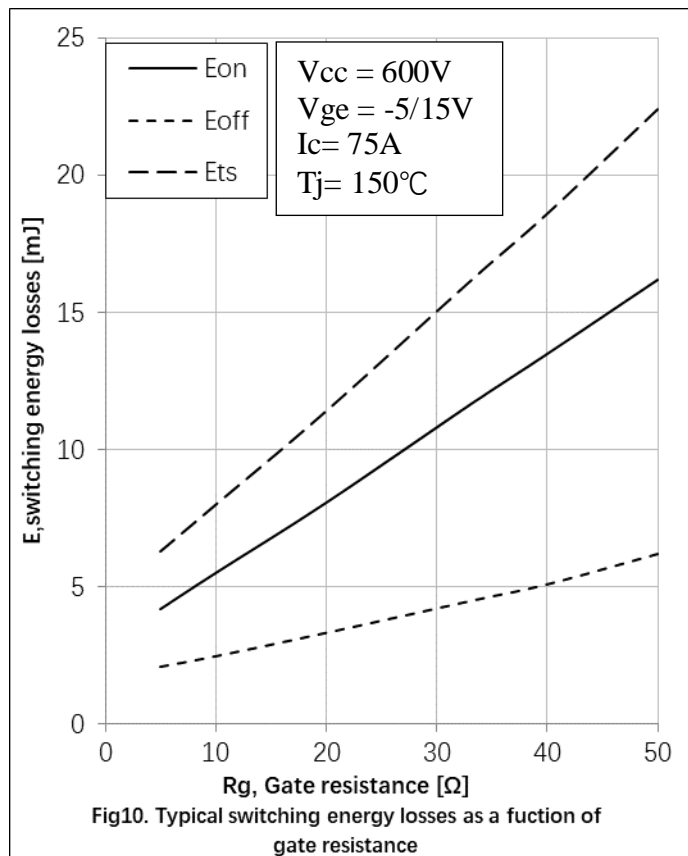
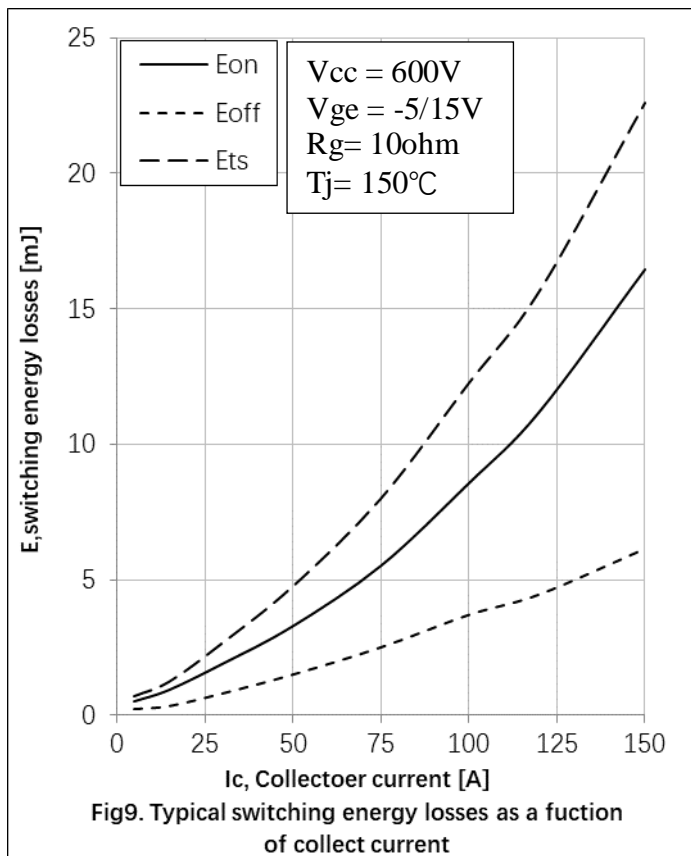

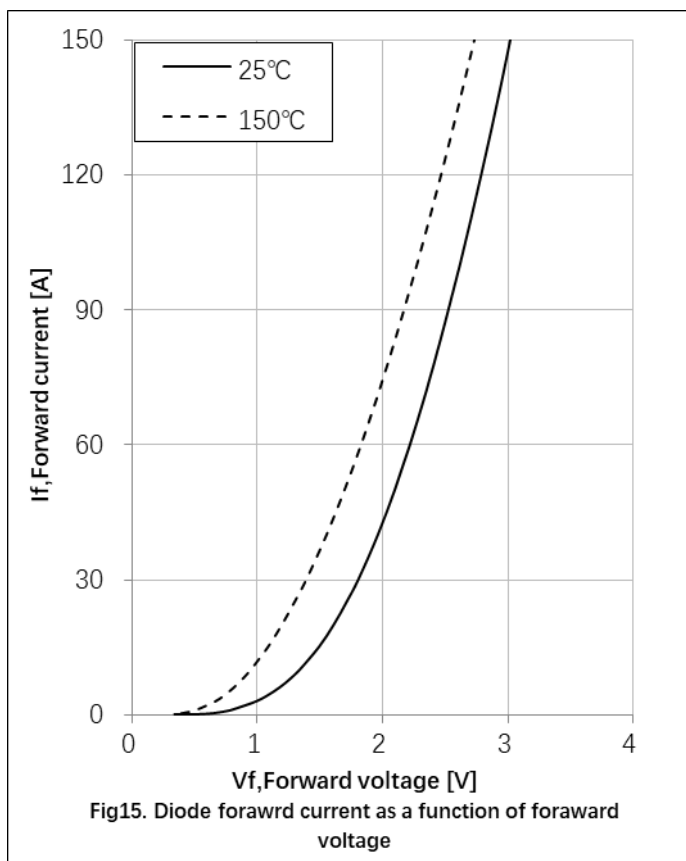
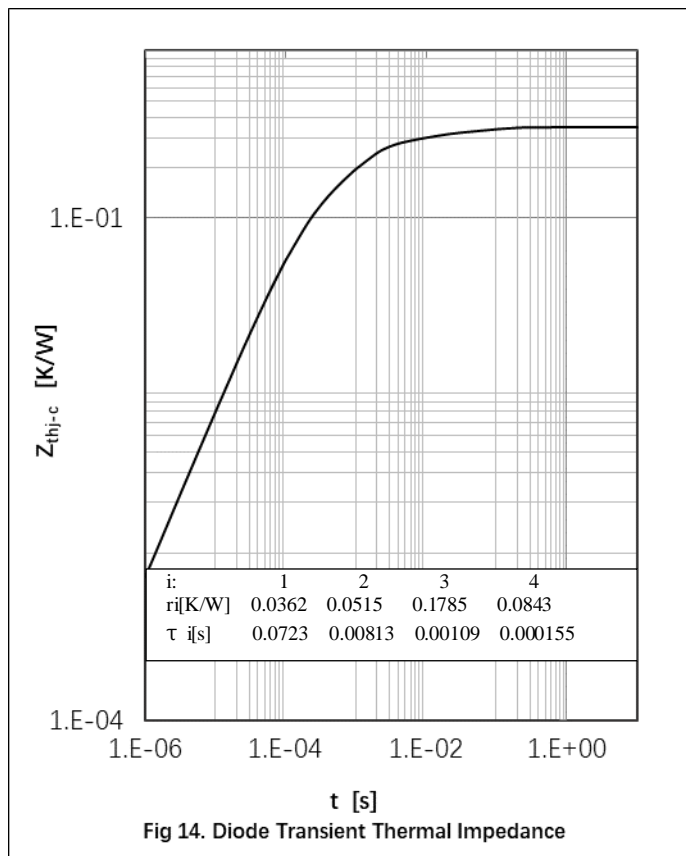
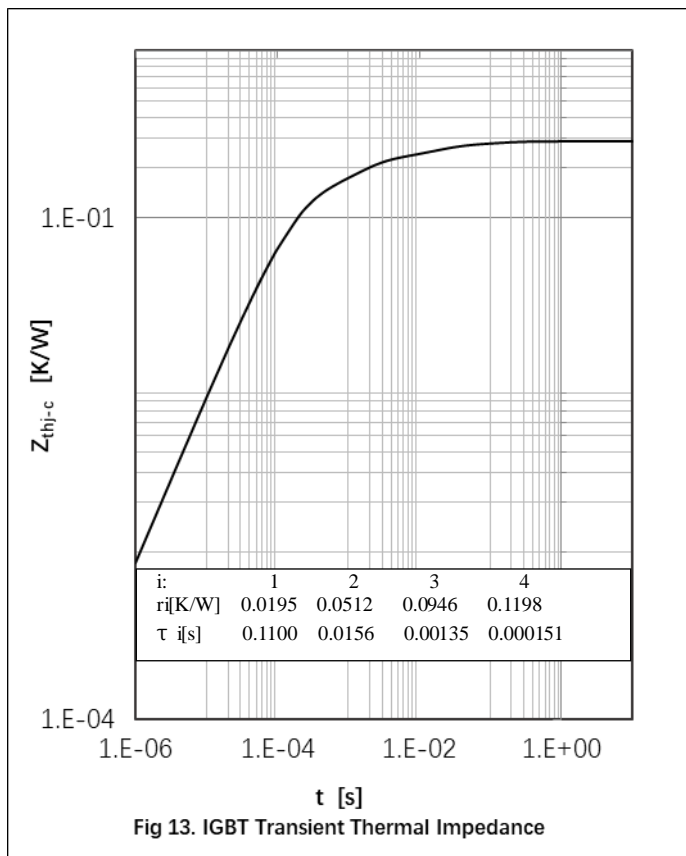

Circuit Diagram

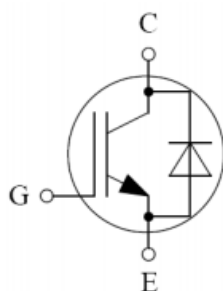

● Package Outline Information

CASE: TO 247plus

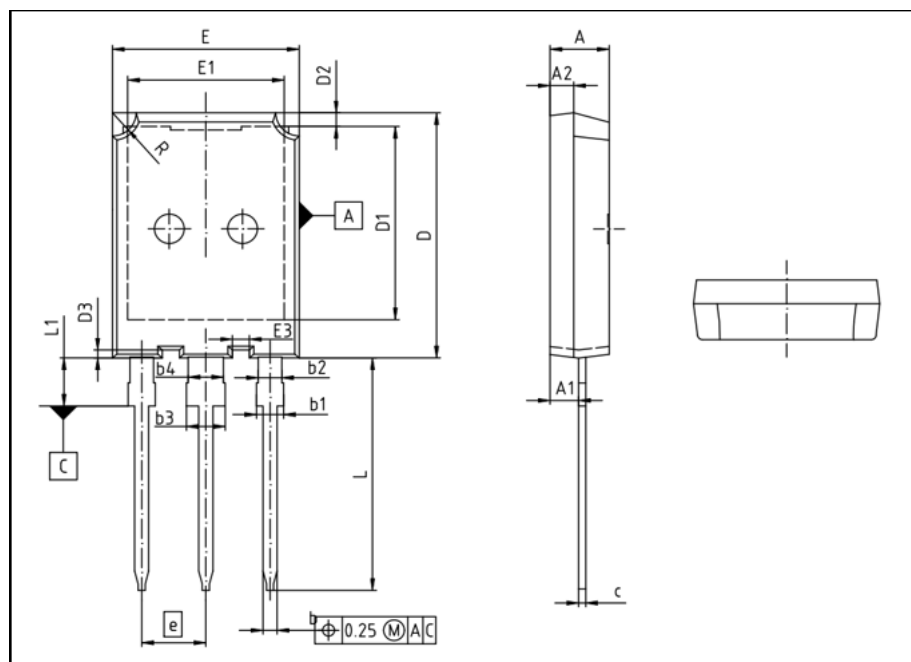

DIM	MILLIMETERS	
	MIN	MAX
A	4.90	5.10
A1	2.31	2.51
A2	1.90	2.10
b	1.16	1.26
b1	1.86	2.16
b2	1.96	2.06
c	0.58	0.64
D	20.90	21.10
D1	16.25	16.85
D2	1.05	1.35
D3	0.58	0.78
E	15.70	15.90
E1	13.10	13.50
E3	1.35	1.55
e	5.44(BSC)	
L	19.78	20.08
L1	4.03	4.23
R	1.90	2.10



Disclaimer

The information presented in this document is for reference only. Yangzhou Yangjie Electronic Technology Co., Ltd. reserves the right to make changes without notice for the specification of the products displayed herein to improve reliability, function or design or otherwise.

The product listed herein is designed to be used with ordinary electronic equipment or devices, and not designed to be used with equipment or devices which require high level of reliability and the malfunction of which would directly endanger human life (such as aerospace machinery, nuclear-reactor controllers, fuel controllers and other safety devices), Yangjie or anyone on its behalf, assumes no responsibility or liability for any damages resulting from such improper use of sale.

This publication supersedes & replaces all information previously supplied. For additional information, please visit our website [http:// www.21yangjie.com](http://www.21yangjie.com) , or consult your nearest Yangjie's sales office for further assistance.