

Digital Transistors (Built-in Resistors)

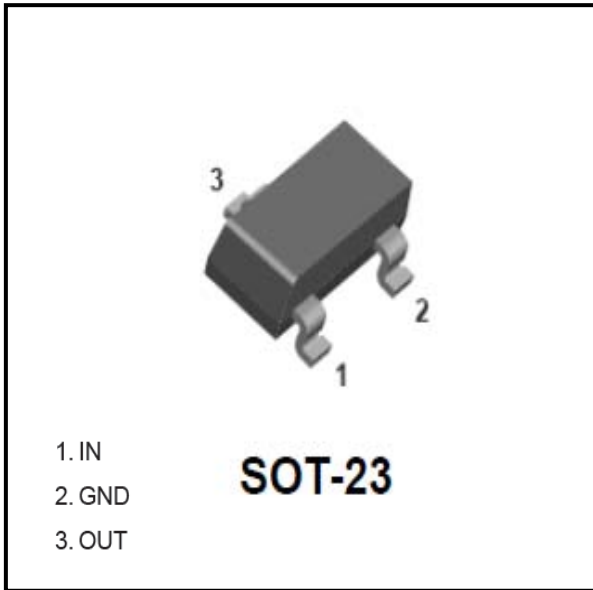

Features

- Epoxy meets UL-94 V-0 flammability rating
- Built-in bias resistors enable the configuration of an inverter circuit without connecting external input resistors
- Surface mount package ideally Suited for Automatic Insertion
- NPN

Mechanical Data

- **Package:** SOT-23
- **Terminals:** Tin plated leads, solderable per J-STD-002 and JESD22-B102
- **Marking:** E21A

■Equivalent circuit

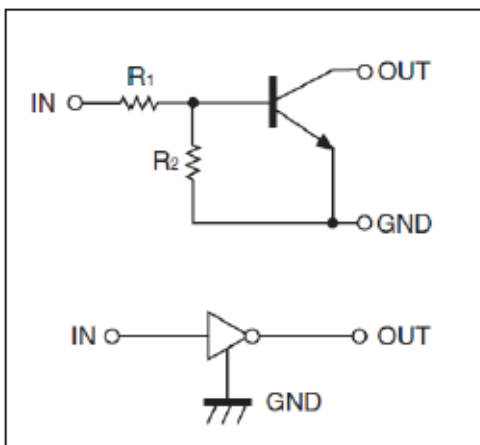

■Maximum Ratings (Ta=25°C Unless otherwise specified)

ITEM	SYMBOL	UNIT	CONDITIONS	VALUE
Supply Voltage	V_{CC}	V		50
Input Voltage	V_{IN}	V		-5 to +10
Output Current	I_o	mA		500
Power Dissipation	P_D	mW		200
Junction Temperature	T_j	°C		150
Storage Temperature	T_{STG}	°C		-55 to +150



DDTC113ZCA

■ Electrical Characteristics (Ta=25°C unless otherwise specified)

ITEM	SYMBOL	UNIT	CONDITIONS	MIN	TYP	MAX
Input voltage	$V_{I(off)}$	V	$V_{CC}=5V, I_c=100\mu A$	0.3		
	$V_{I(on)}$	V	$V_o=0.3V, I_c=20mA$			3
Output voltage	$V_{O(on)}$	V	$I_o / I_i = 50mA / 2.5mA$			0.3
Input current	I_i	mA	$V_i=5V$			7.2
Output current	$I_{O(off)}$	μA	$V_{CC}=50V, V_i=0$			0.5
DC current gain	G_i		$V_o=5V, I_o = 50mA$	56		
Input resistance	R_i	k Ω		0.7	1	1.3
Resistance ratio	R_2/R_1			8	10	12
Transition frequency	f_T	MHz	$V_{CE}=10V, I_E=5mA, f=100MHz$		200	

■ Ordering Information (Example)

PREFERRED P/N	PACKING CODE	UNIT WEIGHT(g)	MINIMUM PACKAGE(pcs)	INNER BOX QUANTITY(pcs)	OUTER CARTON QUANTITY(pcs)	DELIVERY MODE
DDTC113ZCA	F2	Approximate 0.009	3000	30000	120000	7" reel

■ Characteristics (Typical)

Fig. 1 - DC Current Gain Characteristics

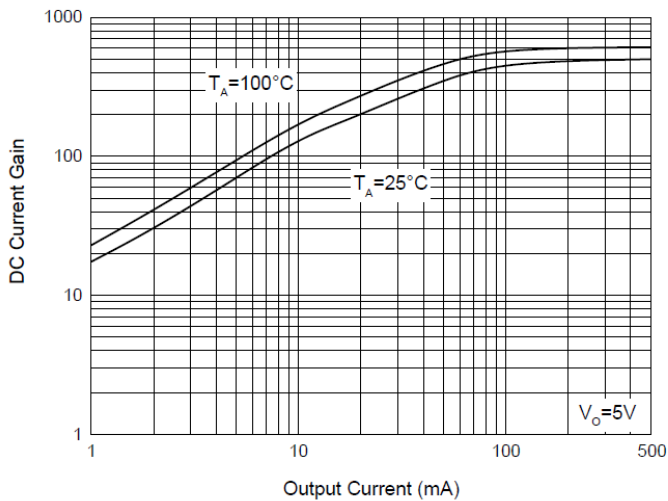
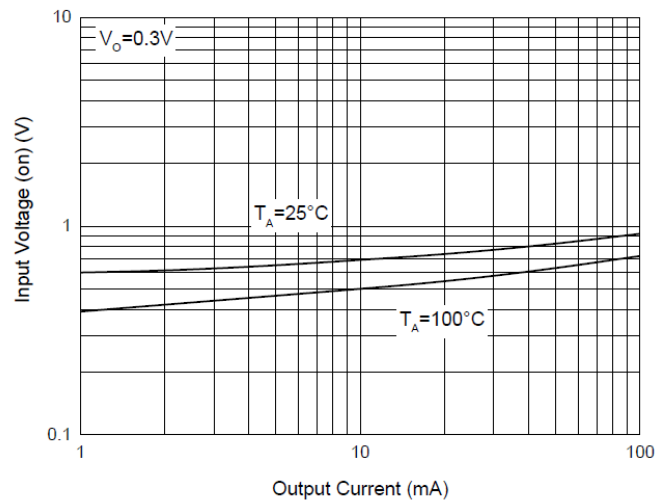

Fig. 2 - Input Voltage (on) Characteristics





DDTC113ZCA

Fig. 3 - Input Voltage (off) Characteristics

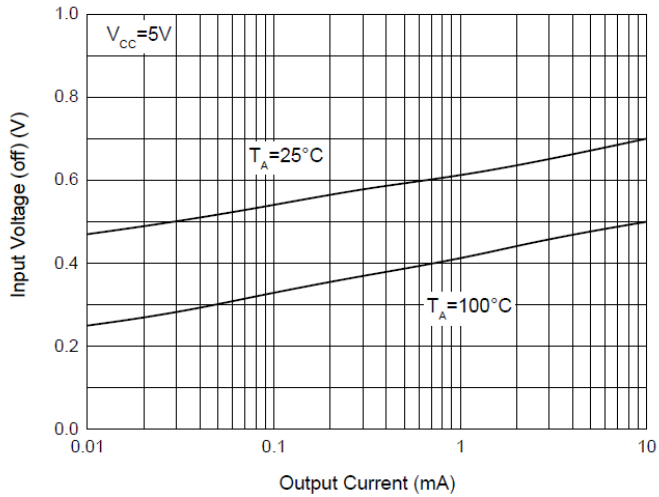
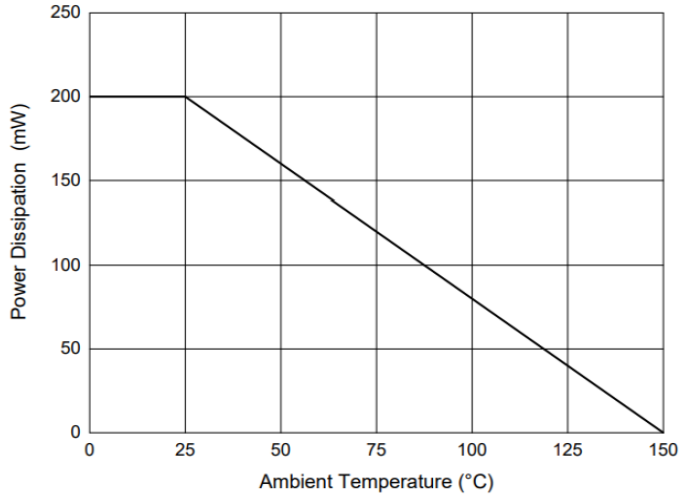
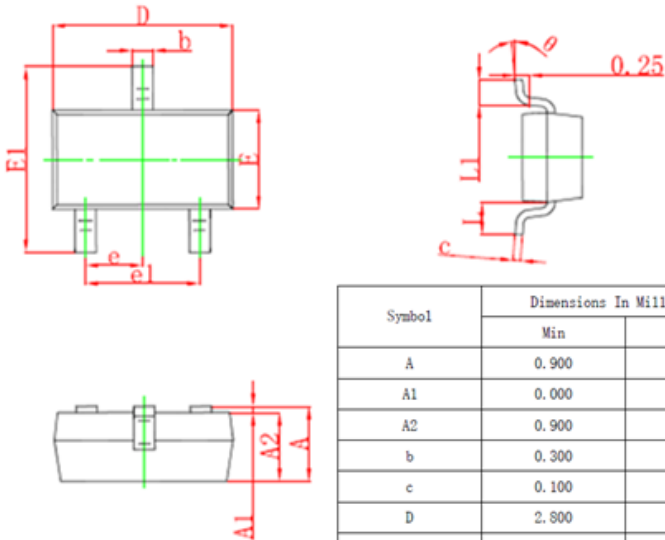

Fig. 4 - Power Derating Curve



■SOT-23 Package Outline Dimensions



Symbol	Dimensions In Millimeters		Dimensions In Inches	
	Min	Max	Min	Max
A	0.900	1.150	0.035	0.045
A1	0.000	0.100	0.000	0.004
A2	0.900	1.050	0.035	0.041
b	0.300	0.500	0.012	0.020
c	0.100	0.200	0.004	0.008
D	2.800	3.000	0.110	0.118
E	1.200	1.400	0.047	0.055
E1	2.250	2.550	0.089	0.100
e	0.950TYP		0.037TYP	
e1	1.800	2.000	0.071	0.079
L	0.550REF		0.022REF	
L1	0.300	0.500	0.012	0.020
θ	0°	8°	0°	8°

■SOT-23 Suggested Pad Layout

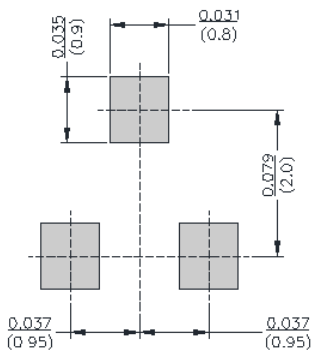



DDTC113ZCA

Disclaimer

The information presented in this document is for reference only. Yangzhou Yangjie Electronic Technology Co., Ltd. reserves the right to make changes without notice for the specification of the products displayed herein to improve reliability, function or design or otherwise.

The product listed herein is designed to be used with ordinary electronic equipment or devices, and not designed to be used with equipment or devices which require high level of reliability and the malfunction of which would directly endanger human life (such as medical instruments, transportation equipment, aerospace machinery, nuclear-reactor controllers, fuel controllers and other safety devices), Yangjie or anyone on its behalf, assumes no responsibility or liability for any damages resulting from such improper use of sale.

This publication supersedes & replaces all information previously supplied. For additional information, please visit our website [http:// www.21yangjie.com](http://www.21yangjie.com) , or consult your nearest Yangjie's sales office for further assistance.